

**PRODUCT TECHNICAL SHEET**

Collection :

Times

Ref. :

**4574.--.28**

Mitigeur de cuisine 2 trous, grand bec mobile 250 mm, mousseur extractible, 1 jet

2-gats ééngreeps keukenmengkraan, grote draaibare uitloop 250mm en uittrekbare perlator, 1 straal

2-hole single-lever kitchen mixer, great swivel spout 250mm, pull-out mousseur, 1 spray

**Picture**

**Product details**



Internal mechanism : Joystick ceramic cartridge (90°)

Note :

Max 5 bars

Provide room for counterweight

**Technical drawing**

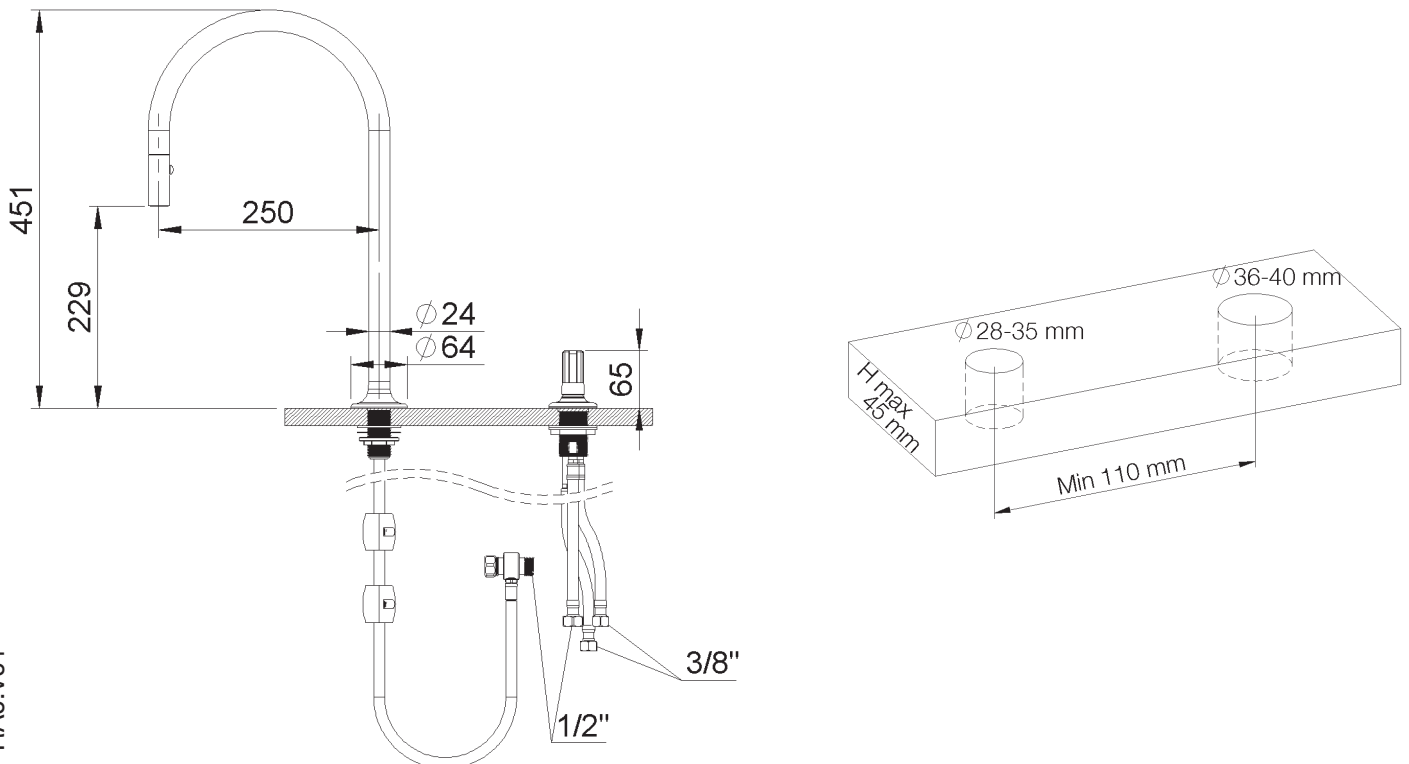

RA0.V01